

*OPTIONAL

REV.	REV./DATE
02	1/01/23

IMPIANTO / INSTALLATION
SCHEMA ELETTRICAVANTONIGLE
220-230 V 1P 50/60HZ

TITOLO / TITLE
SCHEMA FUNZIONALE / ELECTRICAL DIAGRAM
COD.DOC. 413001

N. DIS.	FOGLIO
N. ARCH.	PAGE
DATA EMISSIONE / DATE	TOT. FOGLI
05/12/18	2
	FOGLI
	FOLLOWS
	2

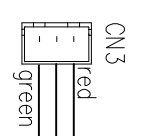
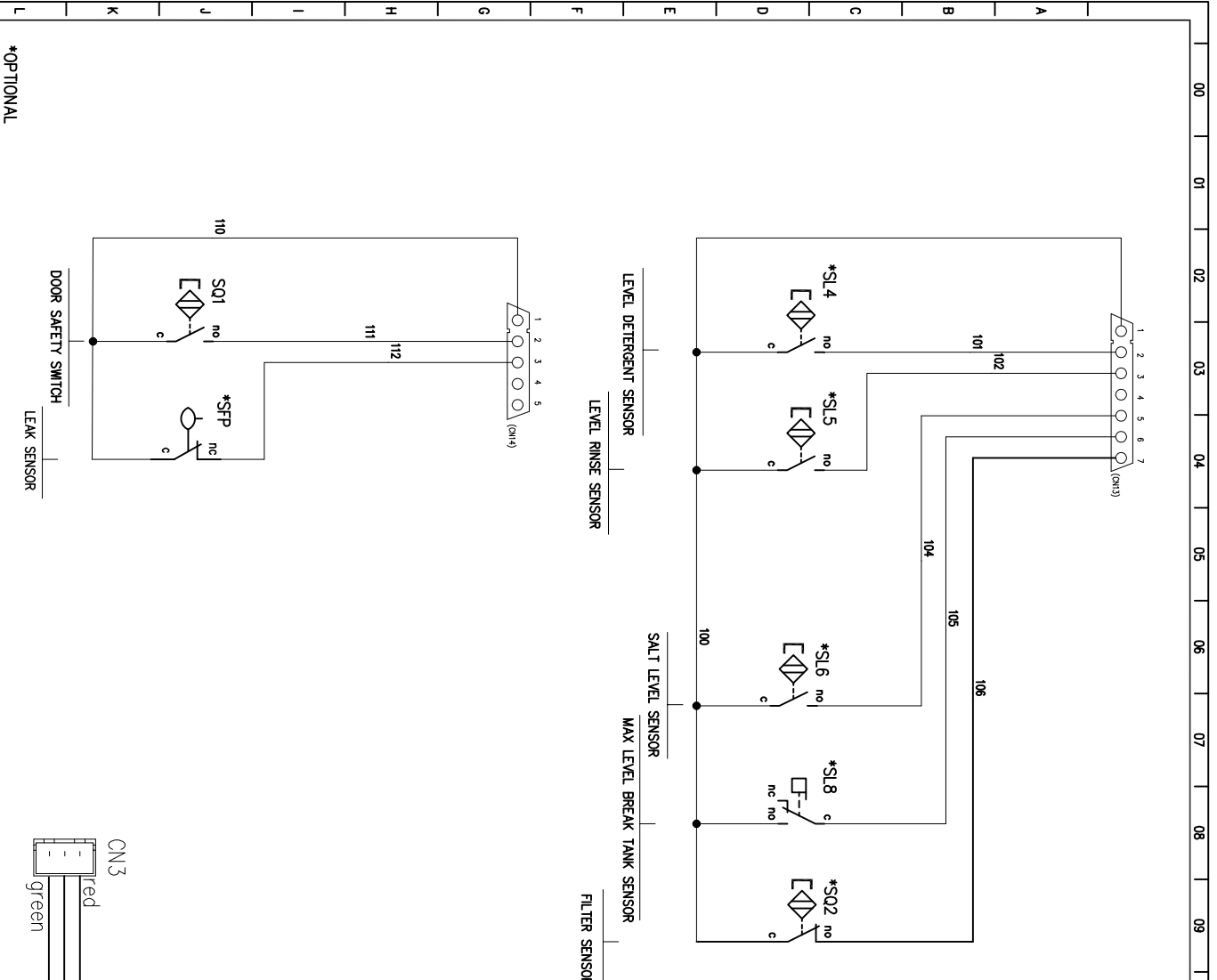

rinse aid dispenser

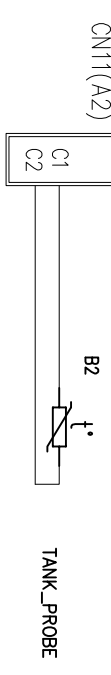
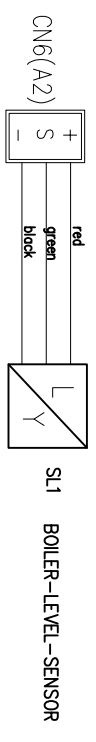
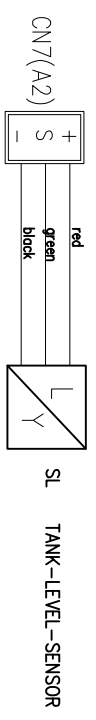
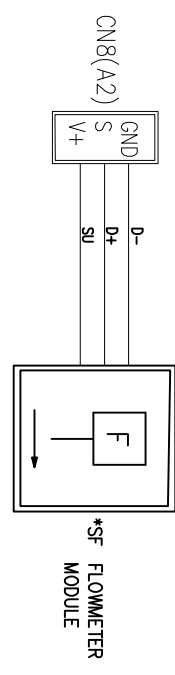

REV. 02	REV./DATE 1/01/23	IMPIANTO / INSTALLATION SCHEMA ELETTAVASTOVIGLIE	TITOLO / TITLE SCHEMA FUNZIONALE / ELECTRICAL DIAGRAM	N. DIS. 41410/DWG	FOGLIO PAGE 2
*OPTIONAL		220-230 V 1P 50/60HZ	SCHEMA FUNZIONALE / ELECTRICAL DIAGRAM	N. ARCH. C-41410	SEGLIE FOLLOWS
			413001	DATA EMISSIONE / DATE 05/12/18	TOT. FOGLI TOT. PAGE 2

RB=6000/4500W
MAIN CABLE 5X1.5mm²

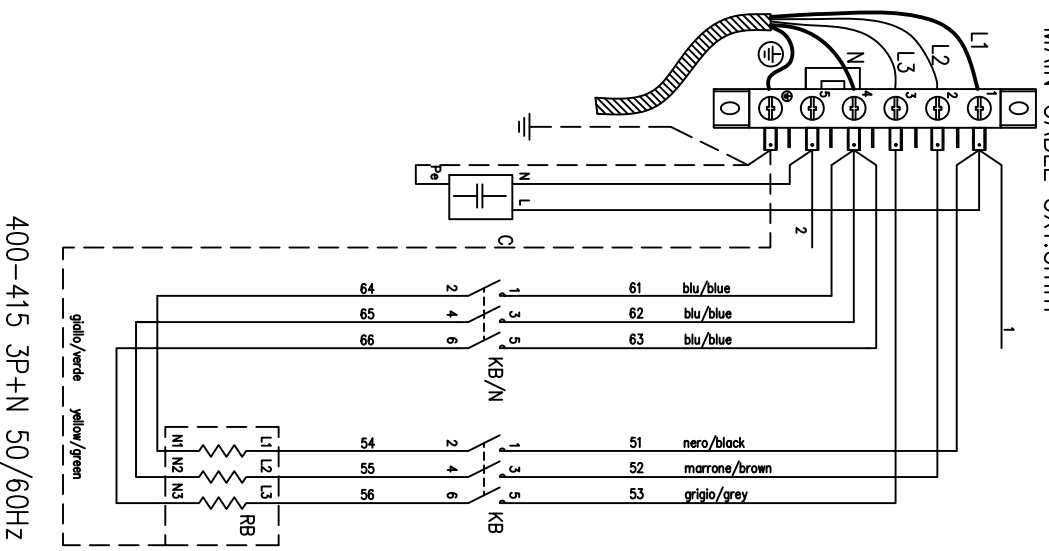

RB=6000/4500W
MAIN CABLE 4X2.5mm²

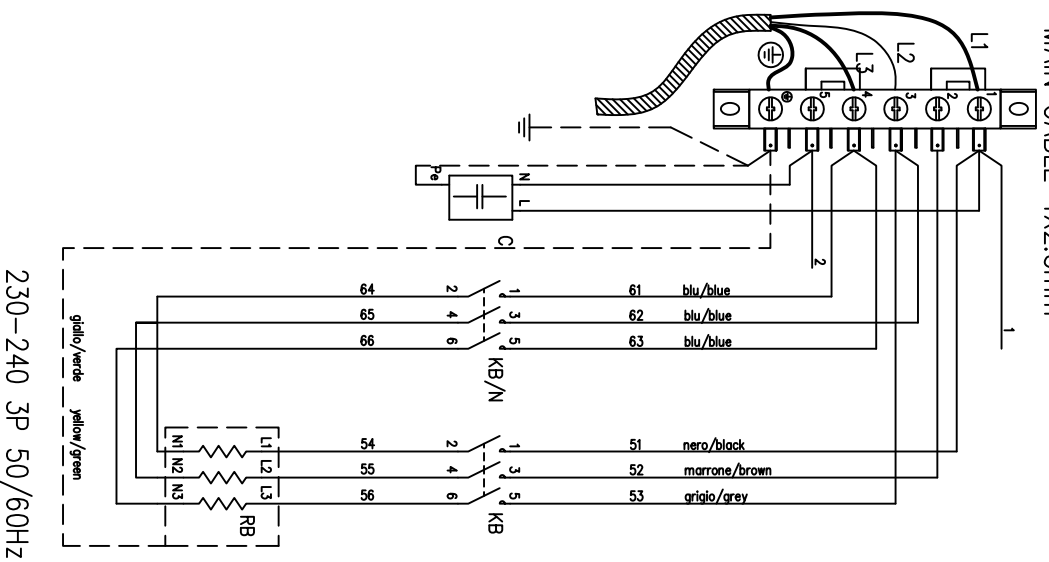

RB=6000/4500W
MAIN CABLE 3X4mm²

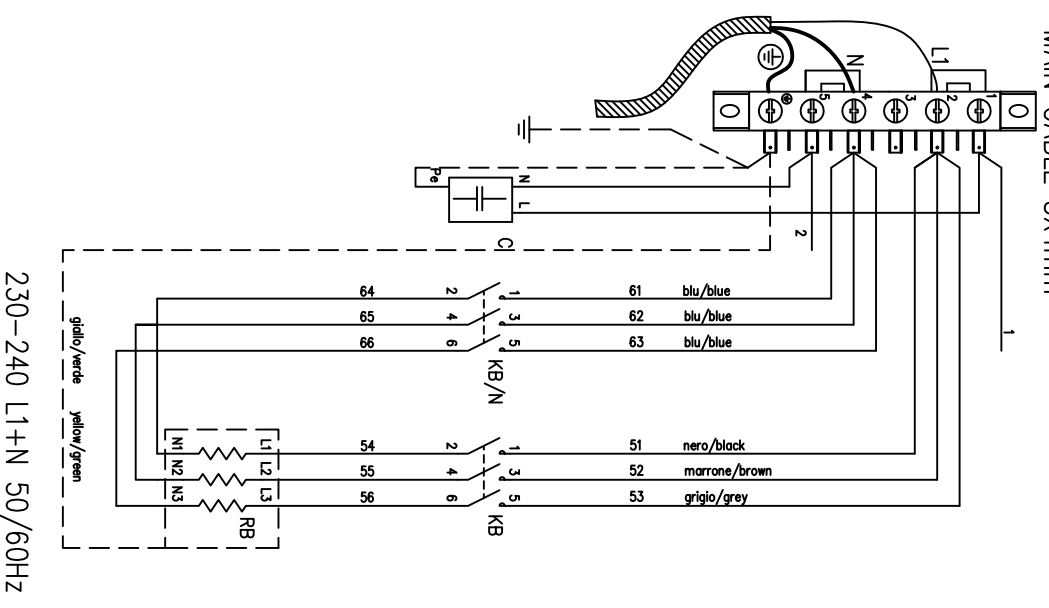

* Element Disconnected

REV.	REV./DATE	IMPIANTO / INSTALLATION	TITOLO / TITLE	N. DIS. / N. ARCH.	FOGLIO PAGE
03	30/05/18	aggiunto cavo	SCHEMA ELET. DI POTENZA / ELECTRIC POWER DIAGRAM	14/04/10	1
					2
COD.DOC.			410706	DATA EMISSIONE / DATE	SEQ. FOLLO
					2

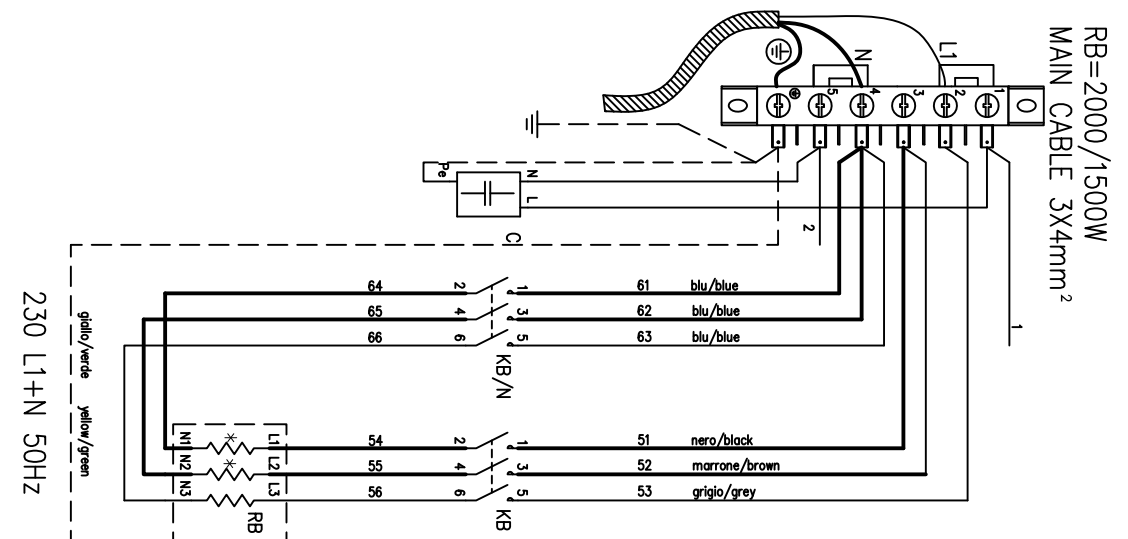
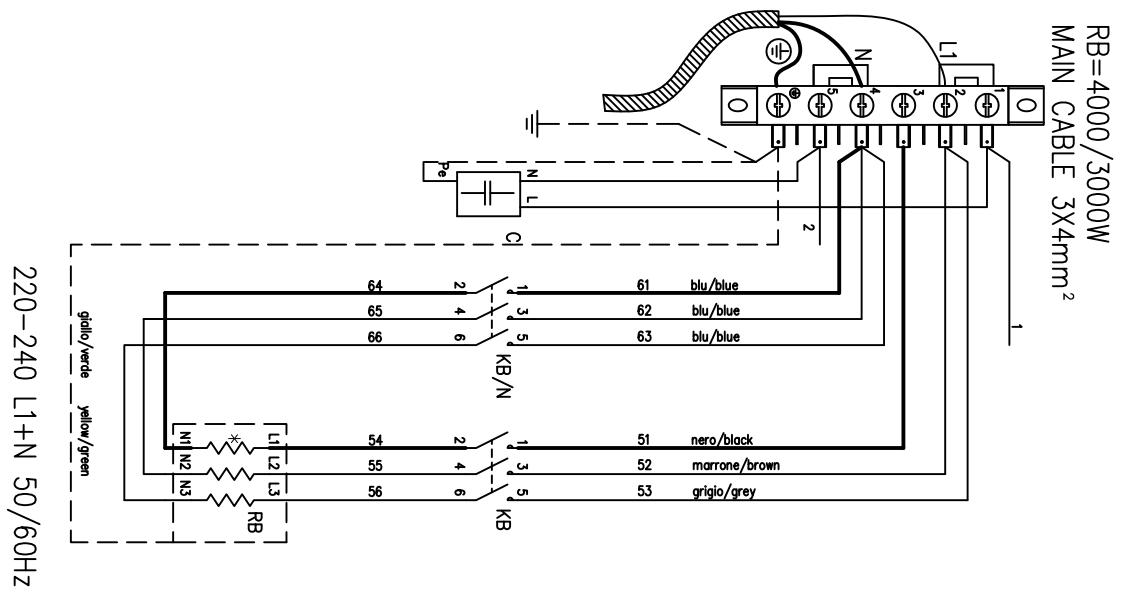

* Element Disconnected

REV.	REV./DATE	IMPIANTO / INSTALLATION		TITOLO / TITLE	N. DIS. / N. ARCH.	Foglio
03	30/05/18	SCHEMA ELETT. L1, L2, L3, N, PE		SCHEMA ELETT. DI POTENZA / ELECTRIC POWER DIAGRAM	14/04/10	2
		aggiunto cavo		COD. DOC.	DATA EMISSIONE / DATE	TOT. FOGLI
				410706		2
						FOGLIO SEQUE
						PAGE FOLLOWS
						2

SELA	ITALIANO	INGLESE	FRANCOSE	TEDESCO	SPAGNOLLO
A1	VALVOLA	SHRVAL	AFFICHIAR	ANZEIGE	TECLADO
A2	SONDA TEMPISTATO BOLLER	MAN BOARD	CORTE DI PASSAGGIO	HAUPTRAHNE	PIOLA DI PORTADA
B1	SONDA TEMPISTATO BOLLER	STROKE BOLLER THERMOSTAT	SONDE THERMOSTAT SURCHAUFFEUR	BOLLER THERMOSTAT	SONDA TEMPISTATO CALIBRINI
B2	SONDA TEMPISTATO VASCA	STROKE TANK THERMOSTAT	SONDE THERMOSTAT CUIVE	TANK THERMOSTAT	SONDA TEMPISTATO CUIVA
B3	SONDA CAMERA LAVAGGIO	WASH CHAMBER PROBE	SONDE CHAMBRE DE LAVAGE	SONDE VAN SOKHABINE	SONDA S.A.L. DE LAVAGIO
B4	SONDA ACQUA INGRESSO	INLET WATER PROBE	SONDE DEAU D'ENTREE	ENWASSERANNAHME	ENTRADA SONDA DE AGUA
C1-2-3	FLUIDO ANTISTURBO	CONDENSER	CONDENSATEUR	KONDENSATOR	FLUIDO ANTI-PERTURBACION
A	CONDENSATORE FRIGIDA	FLUID CONDENSER	CONDENSATEUR FROID	FRIGIDKONDENSATOR	CONDENSADOR FRIGIDA
D1-2-3-4	DODICI	DOORS	DODICE	DOORS	DODICI
E1	BLOCCO PORTA	DOOR LOCK	SERRAGE PORTE	TURBERRIGE	BLOCCO DI PORTATA
E1.1	LED COLORE BLU	LED BLUE	LED COULUR BLEU	LED BLAU	LED COLORE AZZURRO
E1.2	LED COLORE ROSSO	LED RED	LED COULUR ROUGE	LED ROT	LED COLORE ROSSO
E1.3	LED COLORE VERDE	LED GREEN	LED COULUR VERT	LED GRÜN	LED COLORE VERDE
B	PROTEZIONE TERMICA POMPA 1	SAFETY THERMIC SENSOR PUMP 1	SECURITE THERMIQUE POMPE 1	SOBEREITSSENSOR DER PUMPE 1	SECURIDAD TERMICA BOMBA 1
B.1	PROTEZIONE TERMICA POMPA 2	SAFETY THERMIC SENSOR PUMP 2	SECURITE THERMIQUE POMPE 2	SOBEREITSSENSOR DER PUMPE 2	SECURIDAD TERMICA BOMBA 2
F1	RELE TERMICO POMPA 1	THERMIC RELAY PUMP 1	REL AIS THERMIQUE POMPE 1	THERMRELAYS DES POMPES 1	RELE TERMICO BOMBA 1
F1.1	RELE TERMICO POMPA 2	THERMIC RELAY PUMP 2	REL AIS THERMIQUE POMPE 2	THERMRELAYS DES POMPES 2	RELE TERMICO BOMBA 2
F2	RELE TERMICO POMPA 3	THERMIC RELAY PUMP 3	REL AIS THERMIQUE POMPE 3	THERMRELAYS DES POMPES 3	RELE TERMICO BOMBA 3
F3	RELE TERMICO POMPA 4	THERMIC RELAY PUMP 4	REL AIS THERMIQUE POMPE 4	THERMRELAYS DES POMPES 4	RELE TERMICO BOMBA 4
C	RELE TERMICO MOTORI CONDENSER	THERMIC RELAY MOTOR CONDENSER	REL AIS THERMIQUE MOTEUR CONDENSE	THERMRELAYS DES KONDENSATORS	RELE TERMICO MOTORI CALDAIA DE CONDENSACION
F1-2-3-4	FUSIBILI 1-2-3-4	FUSE 1-2-3-4	FUSIBLES 1-2-3-4	SCHWELZSCHREIBUNGEN 1-2-3-4	FUSIBILE 1-2-3-4
G1	ALIMENTATORE CONVERTITORE	POWER SUPPLY CONVERTER	ALIMENTATION CONVERTISSEUR ELECTRIQUE	WANDLER	ALIMENTACION CONVERTIDOR
H1.1	SPA HELE	MAIN SWITCH LIGHT	VOYANT RESERVA ELECTRIQUE	NEUZUMERLEUCHTE	INDICAZIONE SPA HA DE DESACCIO
H1.10	SPA POMPA SCARICO	DRAIN PUMP LIGHT	VOYANT POMPE DE VIDERAGE	KONTROLLLEuchte LAUBERPUMPE	INDICAZIONE SPA HA DE DESACCIO
H2	SPA SCALDO	COYLE LIGHT	VOYANT COLE	KONTROLLLEuchte WARMERHEIZUNG	INDICAZIONE SPA HA DE DESACCIO
H3	SPA RIGENERAZIONE	REGENERATION CYCLE LIGHT	VOYANT REGENERATION	BEHERRERLEuchte	INDICAZIONE SPA HA DE DESACCIO
H4	SPA TEMPERATURA	TEMPERATURE LIGHT	VOYANT TEMPERATUR	TEMPERATURLEuchte	INDICAZIONE TEMPERATURA
H5	SPA ALARME	ALARMWARNING LIGHT	VOYANT ALARME	ALARMAWERSH	INDICAZIONE ALARMA
H6	SPA VASCA	TANK LIGHT	VOYANT INNEAUF CUIVE	TANKWASSERSPEINLEuchte	INDICAZIONE SPA HA
E	SPA SALLE	SALT LIGHT	VOYANT SEL	KONTROLLLEuchte SALZ	INDICAZIONE SPA HA
H8	SPA RISCHIO LAVAGGIO VASCA	TANK HEATING LIGHT	VOYANT CHAUFFAGE CUIVE	KONTROLLLEuchte WARMERHEIZUNG	INDICAZIONE SPA HA DE DESACCIO
H9	SPA RISCHIO LAVAGGIO BOLLER	BOLLER HEATING LIGHT	VOYANT CHAUFFAGE SURCHAUFFEUR	KONTROLLLEuchte BOILERHEIZUNG	INDICAZIONE SPA HA DE DESACCIO
VA	RELE GENERALE	MAIN RELAY	REL AIS	HAUPTRELAYS	RELE GENERALE
VA 1-2-3-4	RELE AUSILIARIO	AUXILIARY RELAY	REL AIS AUXILIAIRES	HILFRELAYS	RELE AUSILIARIO
F	RELE POMPA ALIMENTAZIONE	RELAY BOOSTER PUMP	REL AIS IMPRESSEUR	WASSERHILFRELAYS	RELE BOMBA ALIMENTAZIONE
F1	RELE POMPA GENERALE	MAIN CONTACTOR	TELEOPERIER GEMISSEL	HAUPTRELSCHULTER	RELE POMPA GENERALE
F8	RELE POMPA BOLLER	BOLLER SAFETY CONTACTOR	TELEOPERIER SURCHAUFFEUR	RELSCHULTER DES BOILERS	RELE POMPA BOLLER
F8S	RELE POMPA SCARICO BOLLER	BOLLER SAFETY CONTACTOR	TELEOPERIER SURCHAUFFEUR	SCHWELZERS-FRENSCHULTER DES BOILERS	RELE POMPA BOLLER
K41	TELEBOLLER POMPA LAVAGGIO 1	PUMP CONTACTOR TANK 1	TELEBOLLER PUMPE CUIVE 1	FRENSCHULTER DER WASSERSCHUMPE 1	COMTACTOR BOMBA LAVAGGIO 1
K42	TELEBOLLER POMPA LAVAGGIO 2	PUMP CONTACTOR TANK 2	TELEBOLLER PUMPE CUIVE 2	FRENSCHULTER DER WASSERSCHUMPE 2	COMTACTOR BOMBA LAVAGGIO 2
K43	TELEBOLLER POMPA LAVAGGIO 3	PUMP CONTACTOR TANK 3	TELEBOLLER PUMPE CUIVE 3	FRENSCHULTER DER WASSERSCHUMPE 3	COMTACTOR BOMBA LAVAGGIO 3
K44	TELEBOLLER POMPA LAVAGGIO 4	PUMP CONTACTOR TANK 4	TELEBOLLER PUMPE CUIVE 4	FRENSCHULTER DER WASSERSCHUMPE 4	COMTACTOR BOMBA LAVAGGIO 4
M4	TELEBOLLER POMPA ALIMENTAZIONE	BOOSTER PUMP CONTACTOR	SUBPRESSEUR TELEBOLLER	FRENSCHULTER DER WASSERSCHUMPE 2	COMTACTOR BOMBA ALIMENTAZIONE
M4S	TELEBOLLER POMPA ALIMENTAZIONE	BOOSTER PUMP CONTACTOR	SUBPRESSEUR TELEBOLLER	SCHULTZ ENHILFRELAYS	COMTACTOR BOMBA DE DESCARGA
M46	TELEBOLLER POMPA SCARICO	DRAIN PUMP CONTACTOR	TELEBOLLER POMPE DE VIDERAGE	FRENSCHULTER DES KOMBIMOTORS	COMTACTOR BOMBA MOTORI CESTO
M47	TELEBOLLER POMPA ASPRATA	STEAM CONDENSER CONTACTOR	TELEBOLLER DRAIN PUMPE	FRENSCHULTER DES DAMPKONDENSATORS	COMTACTOR BOMBA MOTORI CESTO
H	TELEBOLLER VASCA	TANK CONTACTOR	TELEBOLLER CUIVE	FRENSCHULTER DER TANK	COMTACTOR SPA
KV1-KV1N	TELEBOLLER SCARICO VASCA	SAFETY TANK THERMOSTAT	THERMOSTAT DE SECURITE CUIVE	SCHWELZERS THERMOSTAT DER TANK	THERMOSTATO SPA HA DE DESACCIO
L	REATTORE	REACTOR	REACTEUR	REAKTOR	BOMBA DE REACCION
MI	POMPA LAVAGGIO 1	PUMP TANK 1	POMPE CUIVE 1	WASSERSCHUMPE 1	BOMBA DE LAVAGGIO 1
MI.1	POMPA LAVAGGIO 2	PUMP TANK 2	POMPE CUIVE 2	WASSERSCHUMPE 2	BOMBA DE LAVAGGIO 2
MI.2	POMPA LAVAGGIO 3	PUMP TANK 3	POMPE CUIVE 3	WASSERSCHUMPE 3	BOMBA DE LAVAGGIO 3
MI.3	POMPA LAVAGGIO 4	PUMP TANK 4	POMPE CUIVE 4	WASSERSCHUMPE 4	BOMBA DE LAVAGGIO 4
MA	DOSAZIONE SALTIZANTE ELETTRICO	ELECTRIC SALTIZING DEVICES	DOSIERS ASSAMMENSEUR ELECTRIQUE	ELEKTROLYSIS SALTIZIERUNGSANLAGEN	DOSIFICAZIONE DE SALTIZANTE ELETTRICO
M1	MOTORI VENTILAZIONE CONDENSER	CONDENSER FAN MOTOR	MOTEUR VENTILATEUR CONDENSER	KONDENSATOR GEBLÄSE MOTOR	MOTORI VENTILAZIONE CONDENSADOR
M2A	POMPA LAVAGGIO 4	PUMP TANK 4	POMPE CUIVE 4	WASSERSCHUMPE 4	BOMBA DE LAVAGGIO 4
M2B	POMPA ALIMENTAZIONE	BOOSTER PUMP	POMPE ALIMENTATION PRESSEION	WASSERSCHUMPE	BOMBA ALIMENTAZIONE
M4	POMPA SCARICO	DRAIN PUMP	POMPE DE VIDERAGE	LAUBERPUMPE	BOMBA DE DESACCIO
M6	DOSAZIONE ELETTRICO	ELECTRIC DEVIANT PUMP	DOSIERS ELECTRIQUE DEBIENT	DOSBEREITUNG	DOSIFICAZIONE DE LARSON ELETTRICO
M6	MOTORI CESTO	ROCK MOTOR	MOTEUR FANMER	KOMBIMOTOR	MOTORI CESTO
M7	MOTORI ASPRATA	STEAM CONDENSER	MOTEUR CONDENSER	DAMPKONDENSATOR	MOTORI ASPRATA
M8	POMPA LIFT	PUMP LIFT	POMPE LIFT	LIFT PUMPE	BOMBA LIFT
M9	DOSAZIONE IRRADIANTE ELETTRICO	ELECTRIC RADIANT HEATER	DOSIERS DE RAYONNEMENT ELECTRIQUE	ELEKTROSTRICHSTRALUNG	DOSIFICAZIONE DE RADIANTE ELETTRICO
M12	MOTORI TUBI	TUBES MOTOR	MOTEUR PROGRAMMABLE TUBER	TUBEMOTOR	MOTORI TUBI
M12V	MOTORI TUBI VELOCITA	FAST TUBES MOTOR	MOTEUR PROGRAMMABLE TUBER A GRANDE VITESSE	SOHNELTUBEMOTOR	MOTORI TUBI VELOCITA
C1	INTERPULSORE GENERALE	MAIN SWITCH	MOTRIER PROGRAMMABLE TUBER A GRANDE VITESSE	HAUPTSCHALTWER	MOTORI TUBI VELOCITA
R6	RESISTENZA BOLLER	BOLLER HEATING ELEMENT	RESISTANCE SURCHAUFFEUR	BOILERHEIZUNG	RESISTENZA CALIBRINI
R7	RESISTENZA VASCA	TANK HEATING ELEMENT	RESISTANCE CUIVE	TANKHEIZUNG	RESISTENZA CALDAIA
L	PULSANTE START CICLO	CYCLE SWITCH	BOUTON DEMARRER	STARTTASTE	BOTON DE CICLO
S10	PULSANTE SET TUBI	TUBE SETTING BUTTON	BOUTON SET TUBER	SETT TUBER EINSTELLKNOFF	BOTON SET TUBI
S2	PULSANTE RIGENERAZIONE	REGENERATION CYCLE SWITCH	BOUTON REGENERATION	REGENERATION TASTE	BOTON DE RIGENERACION

REV.	REV./DATE	IMPIANTO / INSTALLATION	TITOLO / TITLE
06	28/07/20	aggiunte varie	SCHEMA ELETTAVASTOICALE
			LEGENDA SIGLE / LEGEND
			40003
			06/10/2009
			Foglio 1
			Serie 2

